

3" FULL RANGE

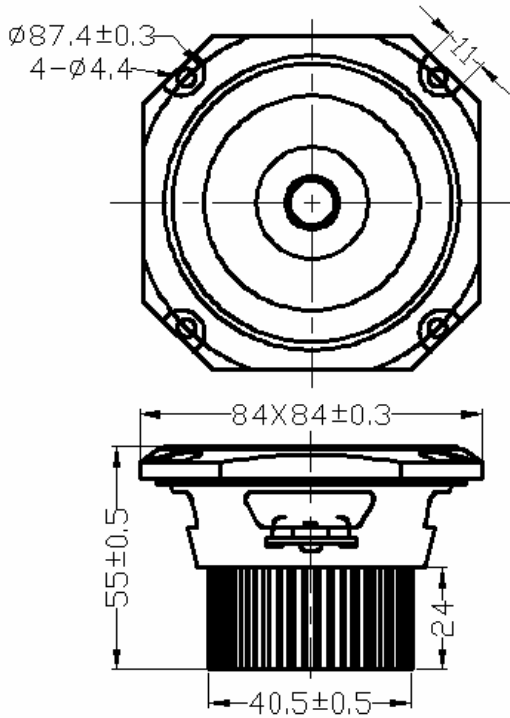

MODEL : UB85B4-10F



Specifications & Thiele/Small Parameters

Impedance	: 4 Ohm
Minimum Frequency Response	: 118Hz
Reproduction Frequency Response	: Fo~20 K
S.P.L.	: 81.991dB/W(m)
Rated Input	: 15W
Music Power	: 20W
Equivalent Diaphragm Radius	: 32 mm
Equivalent Mass	: 1.884 g
Net Weight	: 145 g
Fs	: 117.573 Hz
Re	: 3.6 Ohm
Mms	: 1.998 g
BL	: 1.579TM
Qts	: 1.399
Qms	: 4.113
Qes	: 2.12
Vas	: 1.341 Ltr
Xmax	: 0.85 mm
no	: 0.099 %
Material	Frame : ABS
	Cone : PAPER
	Surround : FABRIC
	Damper : CONEX
	VC DIA : 0.7"
	Magnet : NEODYMIUM

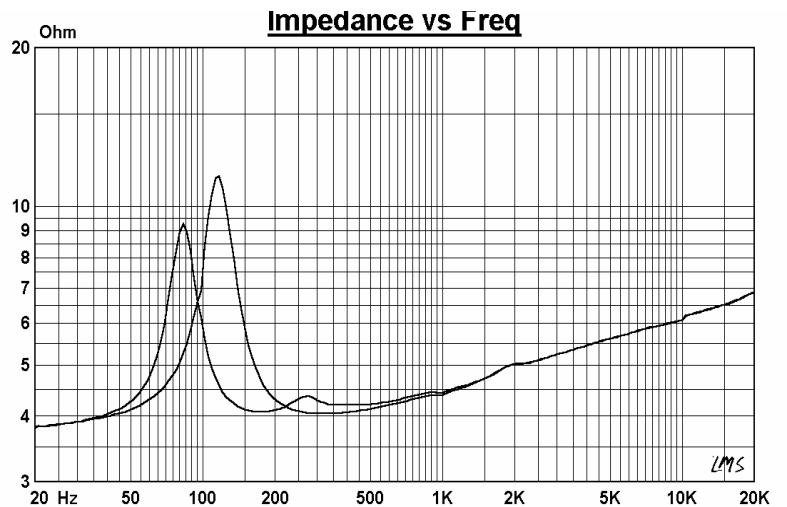
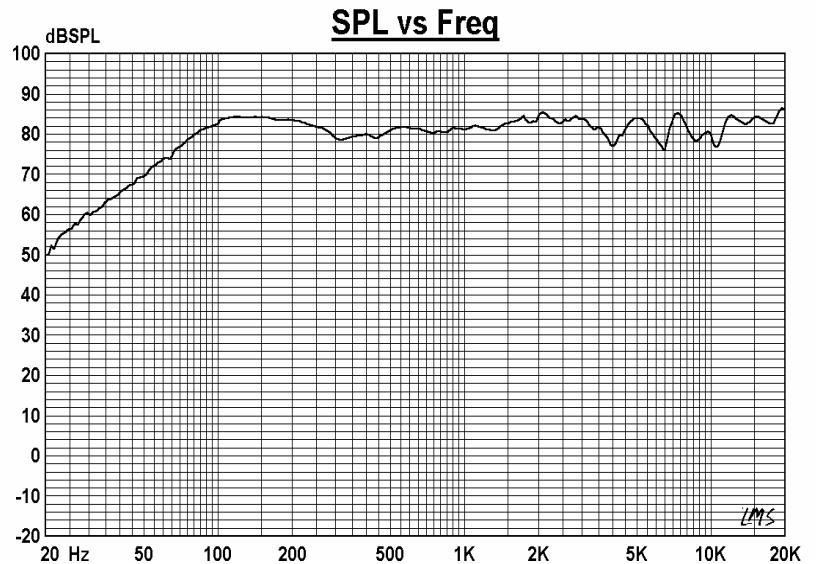

HO-SOUND INDUSTRIES CO.,LTD

E-Mail: tsaichunchang@yahoo.com.tw

Welcome Inquiry&Orders For OEM&ODM

P.5

2005/SEP