

FULL RANGE

Model :FR173B6-12F

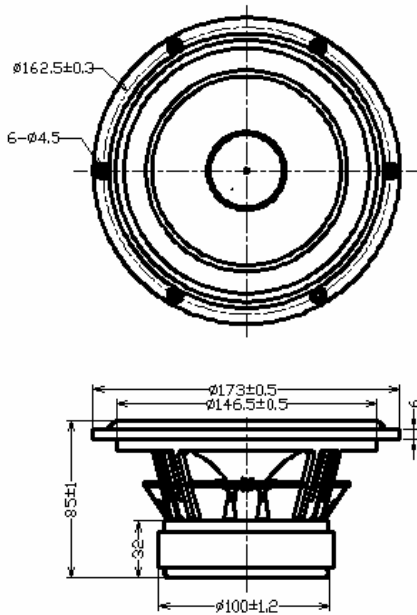

Specifications & Thiele/Small Parameters

Impedance	: 6 Ohm	
Minimum Frequency Response	: 38Hz	
Reproduction Frequency Response	: Fo~18K	
S.P.L.	: 90.094 dB/W(m)	
Rated Input	: 20 W	
Music Power	: 30W	
Equivalent Diaphragm Radius	: 62mm	
Equivalent Mass	: 13.1g	
Magnet Weight	: 630 g	
Net Weight	: 1650g	
Fs	: 38.553 Hz	
Re	: 5.0 Ohm	
Mms	: 11.910g	
BL	: 7.374TM	
Qts	: 0.250	
Qms	: 4.191	
Qes	: 0.265	
Vas	: 30.740Ltr	
Xmax	: 2.5mm	
no	: 0.642%	
Material	Frame	: Cast
	Cone&Sub	: Paper Coating(Black)
	Surround	: RUBBER
	Damper	: CONEX (Hole)
	VC DIA	: 35 KSV 0.21 SV
	Magnet	: 100X 45X20
	Short Ring	: Cu Ring
Center Cap	: ABS Phase Plug (Black)	

SPL vs Freq

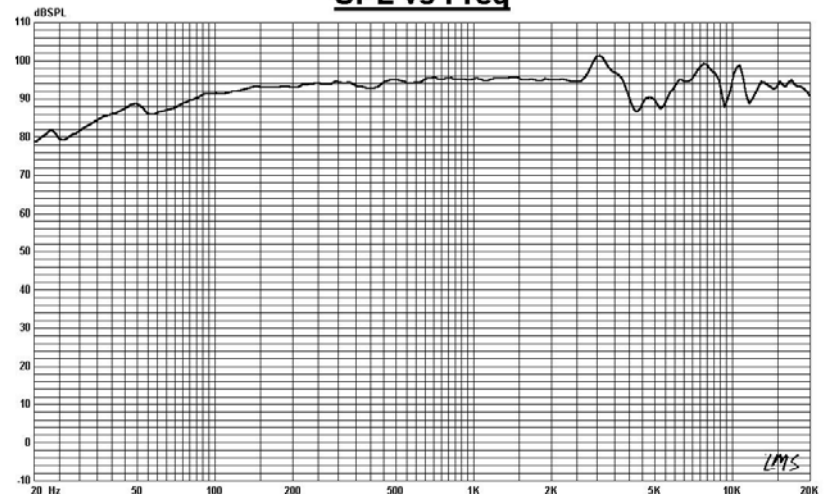

Impedance vs Freq

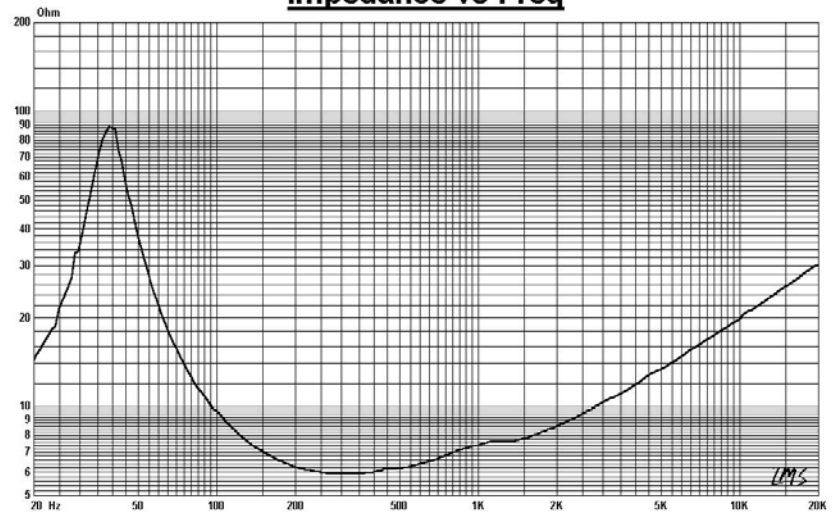

GUIDE-SOUND INDUSTRIES CO.,LTD

E-Mail: Tsaichunchang@yahoo.com.tw

Welcome Inquiry&Orders For OEM&ODM